

# USER'S MANUAL

## Rack Mount CCTV Power Supply Instruction

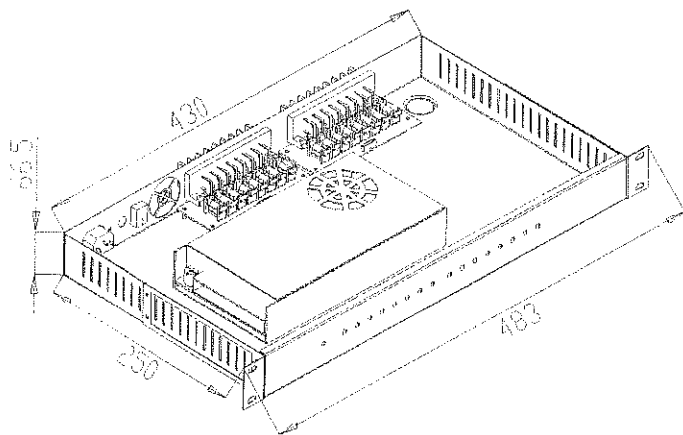

**Facing forward**

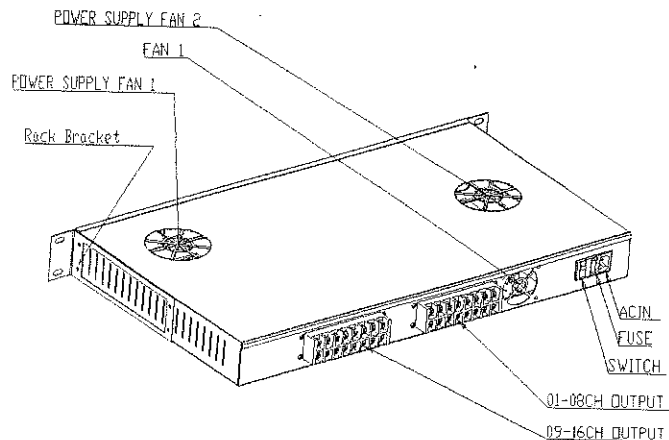

**Facing backward**

### Features:

- 12 ~15 VDC field adjustable output
- Compact 1U height fits into standard 19" equipment racks
- LED status indicator for each output:
- AC power LED indicator
- Power ON/OFF switch
- Rack-mount options:
  - Facing forward – easy access to indicator LEDs
  - Facing backward – easy access to connections
- Removable screw terminal blocks for convenient installation and reliable connections

### Technical parameter

Model	MPS-1.5U400-16F
Fuse type	glass
Input voltage*	86-132VAC
Number of outputs	16Channels
Total supply current	33A
Adjustable voltage output	12V-15V
Fan1/Fan2 working Tmp	exceed 45°C
Rack-mount height	1.5U
Dimensions	483*66.6*250
Weight	4 Kg

Remark: Input Voltage was setted to 110V or 220V, according to country we sale to.

"F" in Model : the power supply with Fan itself

### CAUTION:

 **High Voltage:** This installation should be made by a qualified service person and should conform to all local codes and in accordance with The National Electrical Code or the equivalent.

**Assemble:** Use screw to fix the bracket to rack mount case.

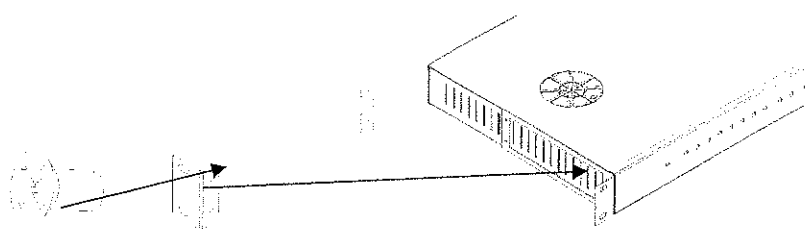

Screw      The bracket      Rack mount case

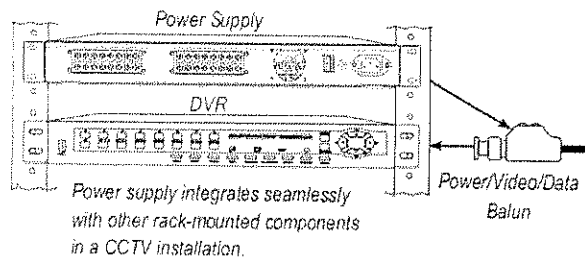

Power supply integrates seamlessly with other rack-mounted components in a CCTV installation.

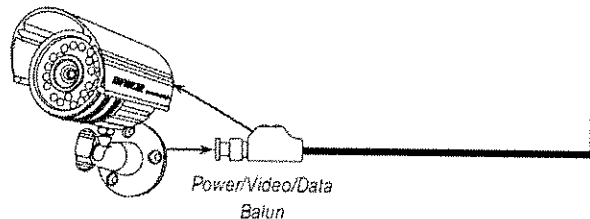

**Connection:**

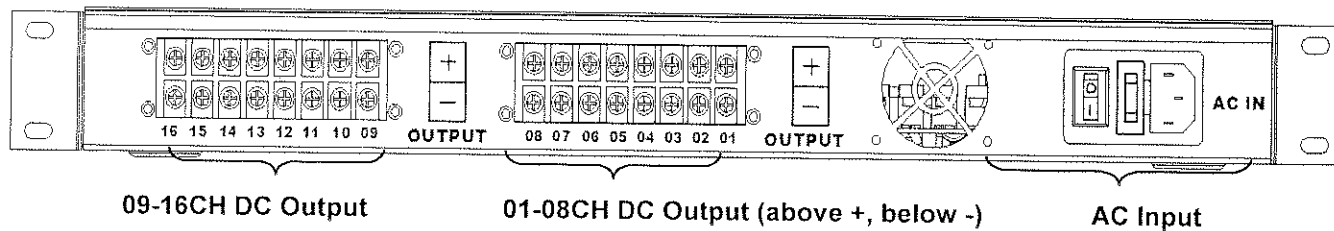

09-16CH DC Output

01-08CH DC Output (above +, below -)

AC Input

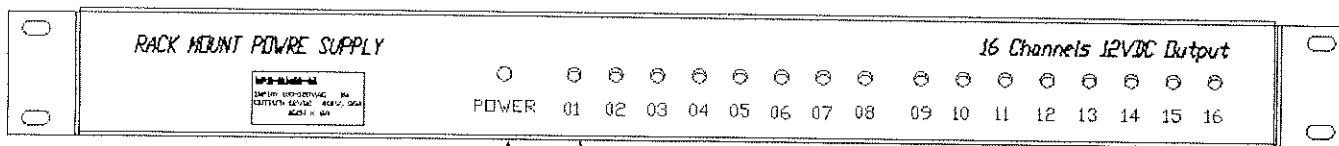

Nameplate

Power Indicator

Output Indicator

**Replace fuse and Voltage adjustment:** Please unload the case cover

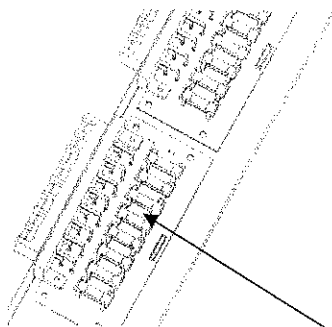

Fuse

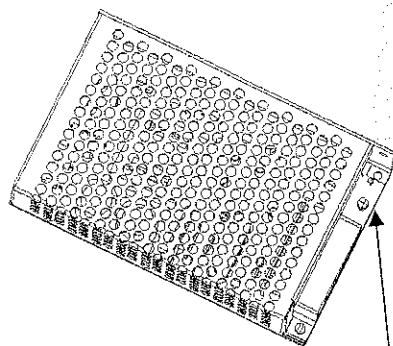

adjustment potentiometer

If your cable distance is such that an excessive voltage drop will occur, you may adjust the output voltage upwards to as much as 13V by turning an adjustment potentiometer on the board of the switch mode power supply. Do not adjust the voltage to a level that exceeds the specified limits of the camera.

**Attachment and Spare List**

NO	Part Name	Qty(PCS)
1	1.5U Rack Mont power Supply	1
2	bracket	2
3	Screw	8
4	AC cable	1

- This instruction manual is the common using version, please regard the actual product as the truth.
- Thank you for purchasing our product. In order to use it correctly and make sure safety, please read the instruction Book carefully before using. Please well